

额定电流: 50A

额定电压: 600V

使用线径: 24-8AWG

目录仅供参考，实际规格依产品工程图为准 版本1.0

技术数据-UL (1059)

等级 Use Group	B	C	D
额定电压 Rate Voltage [V]	600	600	600
额定电流 Rated Current [A]	50	50	5
接线范围 Wire Range [AWG]	24-8		

技术参数-IEC (60947-7-1)

额定电压 Rated Voltage [V]	1000
额定电流 Rated Current [A]	41
单芯 Solid [mm ²]	0.2-10.0
柔性导线 Flexible [mm ²]	0.2-6.0
柔性导线带冷压头 Flexible with ferrule [mm ²]	0.25-6.0
过电压类别 Overvoltage Category	III

污染等级 Contamination Class	3
额定冲击电压 Impulse withstand voltage [KV]	8

材料 Material

绝缘材料 Insulation Material	PA66
阻燃等级 Flame retardant rating	UL94V-0
导体材料 Conductor Material	Copper alloy
导体表面镀层 Plating of conductor surface	Sn plated

一般参数 Other Date

长/高/厚 Length/Height/Thickness [mm]	43.3/42.0/8.2
剥线长度 Stripping Length [mm]	10-11
螺丝/扭矩 Screw/Torque [N.m]	M4/1.2-1.5

尺寸图

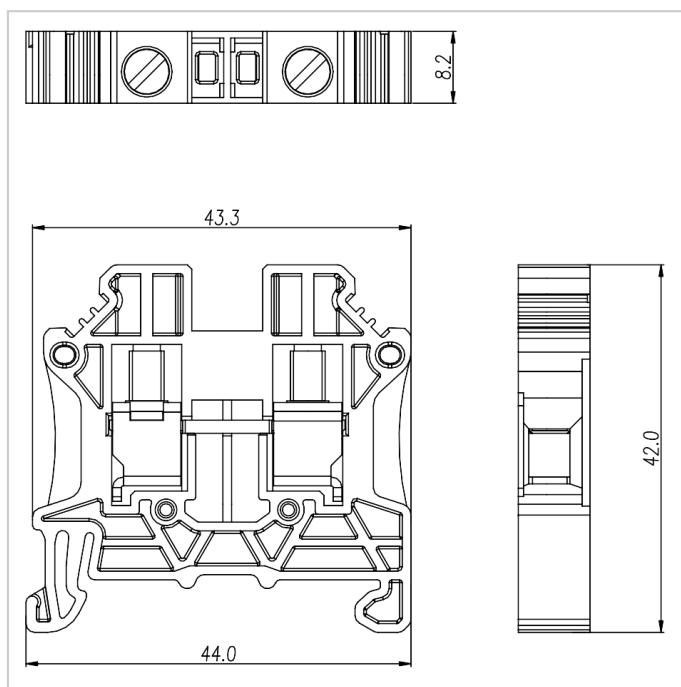

适配产品



FUVA6-XX



DUT10-102



MUV6-10

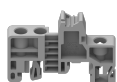

EB-35

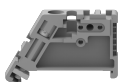

EW-35



EC-35



DGL2-35x7.5A

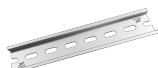

DGL2-35x7.5B

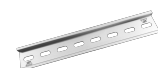

DGL2-35x7.5C



DGL2-35x7.5D