

Connector Series 连接器系列 : M8
 Gender 类型 : Male 公
 Coding 编码 : A, B
 Locking Type 装配方式 : Fix Screw 锁螺丝
 Mounting Type 安装类型: Front Fastened 前锁
 Part No 产品编码 : M08-X**-ST0-M01-BQ4
 X:A, B Coding(A, B扣)
 ** : 03, 04, 05, 06, 08 (Pin数)
 BQ4:4=M11X1.0(OD4)



目录仅供参考，实际规格依产品工程图为准 版本1.0

技术参数 Technical Data

标准 Standard	IEC61076-2-104
工作温度 Ambient Temperatur	-25°C~+85°C
绝缘电阻 Insulation Resistance	≥100MΩ
接触电阻 Contact Resistance	≤5mΩ
防护等级 IP Class	IP67
机械寿命 Mating Endurance	>100 Mating Cycles

材质说明 Material Data

胶芯材料 Connector Carriers	PA
接触端子 Connector Contacts	Copper Alloy With Gold Plated 铜镀金
螺母/螺丝 Connector Nut/Screw	Copper Alloy With Nickel Plated 铜镀镍
密封胶圈 Seal/O-Ring	FKM 氟橡胶

屏蔽 Shielding

Unshielded 非屏蔽

电气参数&机械参数 Electrical Data & Mechanical Date



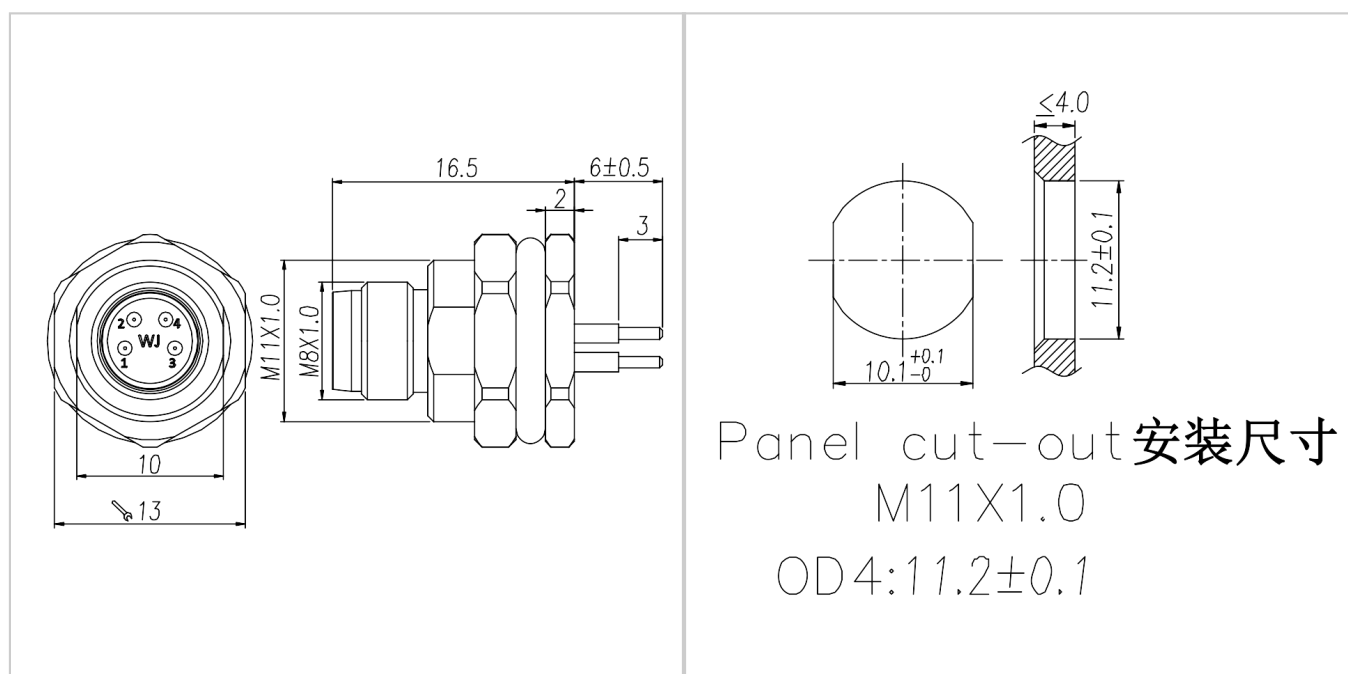

Pin数 Contacts Pin	3/4Pins	5Pins	6/8Pins
额定电流 Rated Current	3A	3A	1.5A
电压 Voltage AC/DC	50V/60V	30V/30V	30V/30V
连接方式 Contacts Termination	PCB Version		

尺寸图

PCB开孔图



规格选型表 Specification Selection Table

Contacts Pin数	Available Coding 防插错编码	Rated Current 额定电流	Voltage 电压		Contacts Termination 连接方式	Part NO.产品编号
			AC	DC		
03Pins	 A-Coding	3A	50V	60V	PCB Version	M08-A03-ST0-M01-BQ4
04Pins	 A-Coding	3A	50V	60V	PCB Version	M08-A04-ST0-M01-BQ4
05Pins	 B-Coding	3A	30V	30V	PCB Version	M08-B05-ST0-M01-BQ4
06Pins	 A-Coding	1.5A	30V	30V	PCB Version	M08-A06-ST0-M01-BQ4
08Pins	 A-Coding	1.5A	30V	30V	PCB Version	M08-A08-ST0-M01-BQ4

配套部件 Matching Parts



M8 母头成型式线缆，直头



M8 母头成型式线缆，弯头

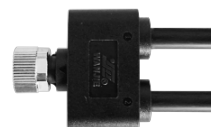

M8 母头成型式双线缆，直头



M8 Y型分配器，公-公-母



M8 Y型分配器，公-母-公