

连接器系列：M12
 类型：Male 公
 编码：A,B,C,D
 装配方式：锁螺丝
 安装类型：法兰类
 产品编号：M12-X**-ST0-M02-BQ0-XXX
 X:A,B,C,D Coding(A,B,C,D扣)
 **:03,04,05...(Pin数)

XXX:050=0.5M,100=1M,10M=10M...(Length长度)



目录仅供参考，实际规格依产品工程图为准 版本1.0

技术参数 Technical Data

标准 Standard	IEC61076-2-101
工作温度 Ambient Temperatur	-25°C~ +80°C
绝缘电阻 Insulation Resistance	≥100MΩ
接触电阻 Contact Resistance	≤10mΩ
防护等级 IP Class	IP67
机械寿命 Mating Endurance	>100 Mating Cycles

材质说明 Material Data

胶芯材料 Connector Carriers	PA
接触端子 Connector Contacts	Copper Alloy With Gold Plated 铜镀金
螺母/螺丝 Connector Nut/Screw	Copper Alloy With Nickel Plated 铜镀镍
密封胶圈 Seal/O-Ring	NA 无
屏蔽 Shielding	Unshielded 非屏蔽
连接方式 Contacts Termination	Solder Type 焊接式







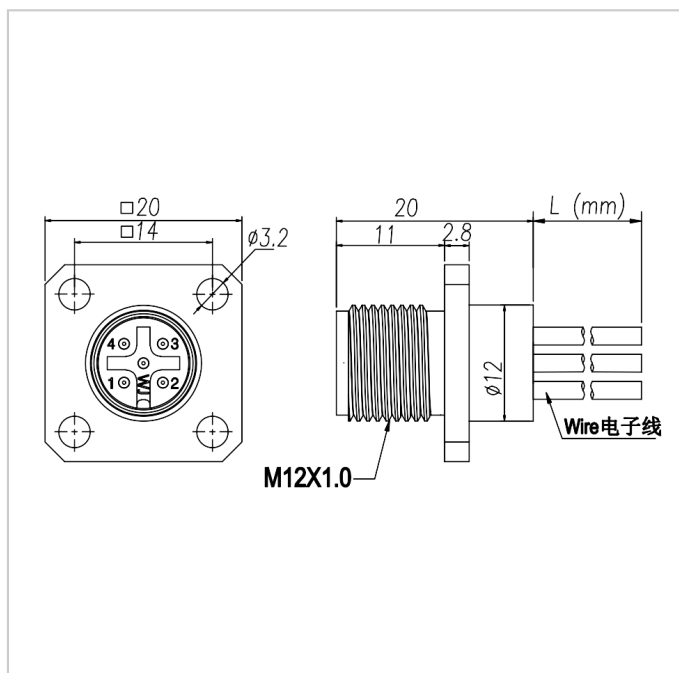







电气参数&机械参数 Electrical Data & Mechanical Date

Pin数 Contacts Pin	3/4Pins	5Pins	6/8Pins	12/17Pins
额定电流 Rated Current	4A	4/2A	2A	1.5A
电压 Voltage AC/DC	250V	60V	30V	30V
接线范围 Wire Range AWG/mm ²	22/0.34	22, 24/0.34 , 0.25(C- code)	24/0.25	26/0.14

尺寸图



规格选型表 Specification Selection Table

Contacts Pin数	Available Coding 防插错编码				Rated Current 额定电流	Voltage 电压		Wire Range 接线范围		Part NO. 产品编号
	A-Coding	B-Coding	C-Coding	D-Coding		AC	DC	AWG	mm ²	
03Pins					4A	250V	250V	22	0.34	M12-A03-ST0-M02-BQ0-XXX M12-B03-ST0-M02-BQ0-XXX M12-C03-ST0-M02-BQ0-XXX
04Pins					4A	250V	250V	22	0.34	M12-A04-ST0-M02-BQ0-XXX M12-B04-ST0-M02-BQ0-XXX M12-C04-ST0-M02-BQ0-XXX M12-D04-ST0-M02-BQ0-XXX
05Pins					4A 2A	60V	60V	22 24 (C-code)	0.34 0.25 (C-code)	M12-A05-ST0-M02-BQ0-XXX M12-B05-ST0-M02-BQ0-XXX M12-C05-ST0-M02-BQ0-XXX
06Pins					2A	30V	30V	24	0.25	M12-C06-ST0-M02-BQ0-XXX
08Pins					2A	30V	30V	24	0.25	M12-A08-ST0-M02-BQ0-XXX
12Pins					1.5A	30V	30V	26	0.14	M12-A12-ST0-M02-BQ0-XXX
17Pins					1.5A	30V	30V	26	0.14	M12-A17-ST0-M02-BQ0-XXX

配套部件 Matching Parts



M12 母头成型式线缆，直头，非屏蔽



M12 母头成型式线缆，弯头，非屏蔽



M12 母头成型式线缆，直头，屏蔽



M12 母头成型式线缆，弯头，屏蔽



母头成型式双线缆，直头



Y型分配器，公-公-母



Y型分配器，母-公-母



面板式 I型转接器，公-母



M12 母头成型式堵头



母头成型式线缆，直头，非屏蔽，不锈钢
螺母



母头成型式线缆，弯头，非屏蔽，不锈钢
螺母

母头成型式线缆，直头，屏蔽，不锈钢螺
母

母头成型式双线缆，直头，不锈钢螺母