



Connector : M12
 Gender : Female
 Coding : A,B,D
 Locking Type : Fix Screw
 Mounting Type : Field Assemble
 Part No : M12-X**-RA2-F04-BS*
 X:A,B,D Coding
 **:03,04,05...8 (Pin)
 *:1=Cable OD4.0~6.0MM
 *:2=Cable OD6.0~8.0MM...

For reference only!version1.0

Technical Data

Standard	IEC61076
Ambient Temperatur	-25°C--+105°C
Insulation Resistance	≥100MΩ
Contact Resistance	≤5mΩ
IP Class	IP67
Mating Endurance	>100 Mating Cycles

Material Data







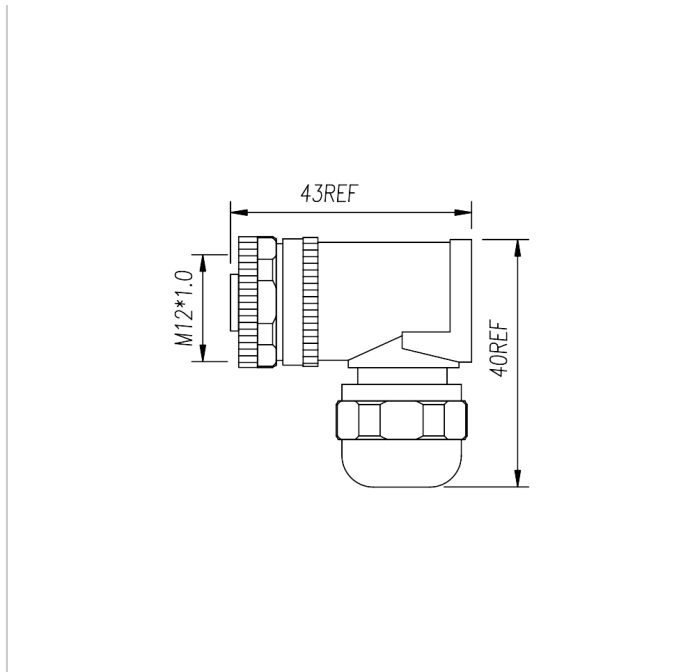

Connector Carriers	Copper Alloy With Nickel Plated 铜合金镀镍
Connector Contacts	Copper Alloy With Gold Plated 铜镀金
Connector Nut/Screw	Copper Alloy With Nickel Plated 铜镀镍
Seal/O-Ring	FKM 氟橡胶
Shielding	Shielded 屏蔽
Contacts Termination	Terminal Locking Screw 锁螺钉连接

Dimensions





Specification Selection Table

Contacts Pin数	Available Coding 防插错编码			Rated Current 额定电流	Voltage 电压		Wire Range 接线范围		Part NO. 产品编号
	A-Coding	B-Coding	D-Coding		AC	DC	AWG	mm ²	
03Pins				4A	250V	250V	22	0.34	M12-A03-RA2-F04-BS* M12-B03-RA2-F04-BS*
04Pins				4A	250V	250V	22	0.34	M12-A04-RA2-F04-BS* M12-B04-RA2-F04-BS* M12-D04-RA2-F04-BS*
05Pins				4A	60V	60V	22	0.34	M12-A05-RA2-F04-BS* M12-B05-RA2-F04-BS*
08Pins				2A	30V	30V	24	0.25	M12-A08-RA2-F04-BS*