

M8 Male Panel Mount, PCB Type, Rear Fastened

M8 Circular Connector

Download date : 2025-12-06

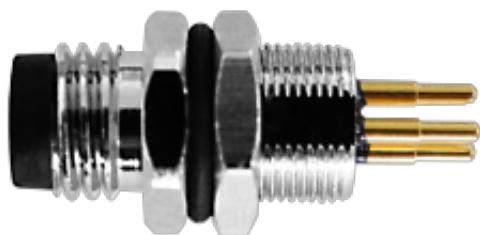

Connector Series : M8

Gender : Male

Coding : A, B

Locking Type : Fix Screw

Mounting Type: Rear Fastened

Part No : M08-X**-ST0-M01-BH2

X:A, B Coding

** : 03, 04, 05, 06, 08 (Pin)

BH2:2=M8X0.5(OD2)



For reference only!version1.0

Technical Data

Standard	IEC61076-2-104
Ambient Temperatur	-25°C~+85°C
Insulation Resistance	≥100MΩ
Contact Resistance	≤5mΩ
IP Class	IP67
Mating Endurance	>100 Mating Cycles

Material Data

Connector Carriers	PA
Connector Contacts	Copper Alloy With Gold Plated 铜镀金
Connector Nut/Screw	Copper Alloy With Nickel Plated 铜镀镍
Seal/O-Ring	FKM 氟橡胶

M8 Male Panel Mount, PCB Type, Rear Fastened

M8 Circular Connector

Download date : 2025-12-06



Shielding	Unshielded 非屏蔽		
-----------	----------------	--	--

Electrical Data & Mechanical Date

Contacts Pin	3/4Pins	5Pins	6/8Pins
Rated Current	3A	3A	1.5A
Voltage AC/DC	50V/60V	30V/30V	30V/30V
Contacts Termination	PCB Version		

Dimensions

PCB opening diagram

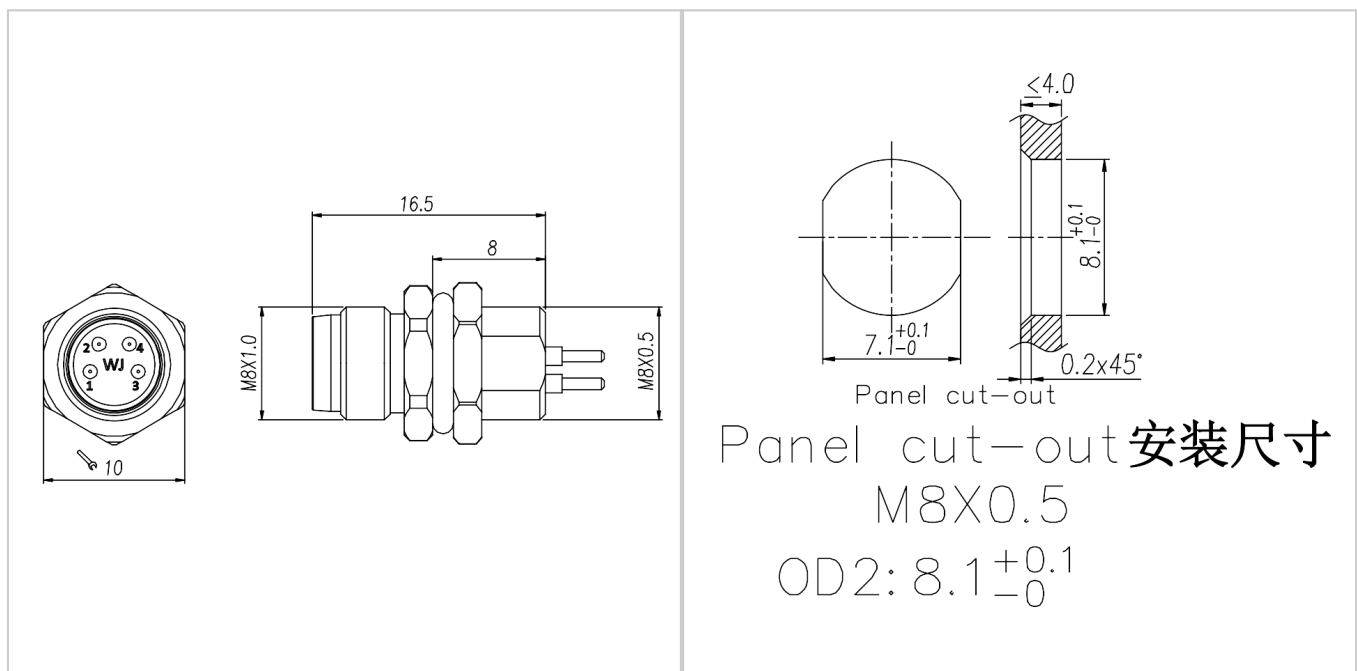





Specification Selection Table

M8 Male Panel Mount, PCB Type, Rear Fastened

M8 Circular Connector

Download date : 2025-12-06



Contacts Pin数	Available Coding 防插错编码	Rated Current 额定电流	Voltage 电压		Contacts Termination 连接方式	Part NO.产品编号
			AC	DC		
03Pins	 A-Coding	3A	50V	60V	PCB Version	M08-A03-ST0-M01-BH2
04Pins	 A-Coding	3A	50V	60V	PCB Version	M08-A04-ST0-M01-BH2
05Pins	 B-Coding	3A	30V	30V	PCB Version	M08-B05-ST0-M01-BH2
06Pins	 A-Coding	1.5A	30V	30V	PCB Version	M08-A06-ST0-M01-BH2
08Pins	 A-Coding	1.5A	30V	30V	PCB Version	M08-A08-ST0-M01-BH2